

SCOOPS

940-SCM-RDBK N



Specifications:

TYPE Scoop
VOLUME 94 cc
HANDLE Medium
DESIGN Round
MATERIAL PP

PACKAGING & FREIGHT INFORMATION

PACK TYPE	PCS/CTN	CTNS/PALT	PCS/PALT	CTN WT*	PALT WT*	FRT CLASS
Bulk	350	24	8,400	11	314	250
CARTON DIMENSIONS: 19 x 15 x 18			PALLET DIMENSIONS: 40 x 48 x 80			

*Approximate

MARKETS

Nutritional Powders, Powdered Drinks, Baby Formulas, Household Chemical; Cleaning Products; Pet Products; Plant Food & Fertilizers

OPTIONS

Available in natural, white, black and colors. Custom logo engraving available.

SCOOP BENEFITS

- Manufactured by HQC
- Customization options available
- Popular for nutritional powders

SCOOPS

940-SCM-RDBK N

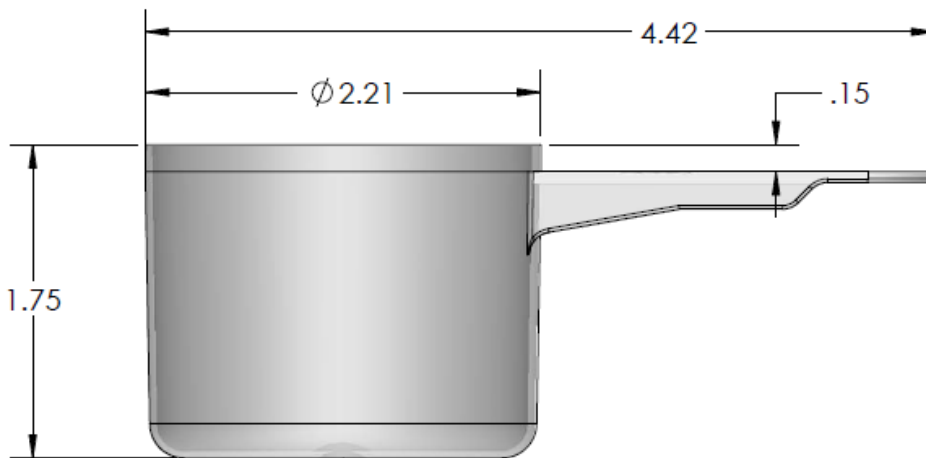
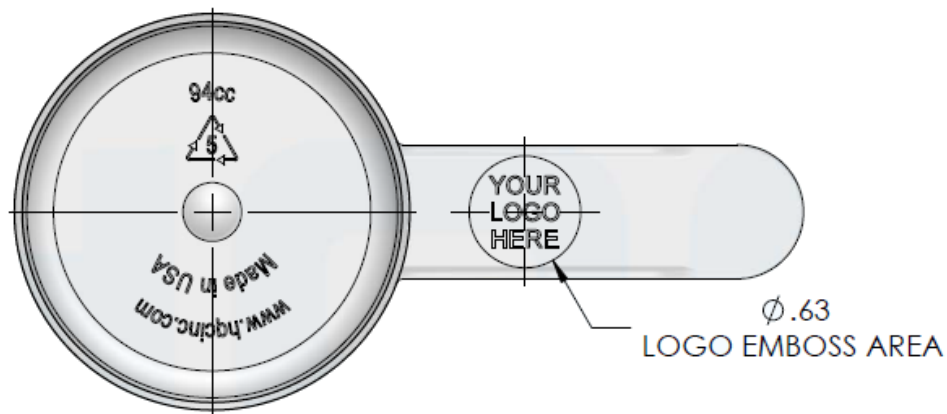

NOTES: (UNLESS OTHERWISE SPECIFIED) 1. ALL DIMENSIONS ARE IN INCHES. 2. SEE CHART FOR DIMENSIONAL TOLERANCE. THIS OR FACSIMILE THEREOF IS THE EXCLUSIVE PROPERTY OF PHOENIX AND MAY NOT BE REPRODUCED WITHOUT THE EXPRESSED WRITTEN CONSENT OF PHOENIX. SOME OR ALL OF THE ITEMS DEPICTED ON THIS DRAWING MAY BE COVERED BY CURRENT PATENTS OR PATENTS APPLIED FOR BY PHOENIX.	- 00.00.00 -		--						
	REV	DATE	DESCRIPTION	BY					
	TOLERANCE	PITCH/TPI	NA / 0	TURNS x	MAT'L	PP			
	.X	±0.1	DRAWN	HQC	DATE	01.06.15	SCALE	0 : 1	REV
	.XX	±0.02	940 - SCM - RDBK N		0				
.XXX	±0.010								



PHXPKG.COM

P 630 420 4750 E greatpkg@phxpkg.com
 975 Meridian Lake Drive • Aurora, IL 60504